

*The* **REVSPEC**  
**PRIMES**

PR-H028

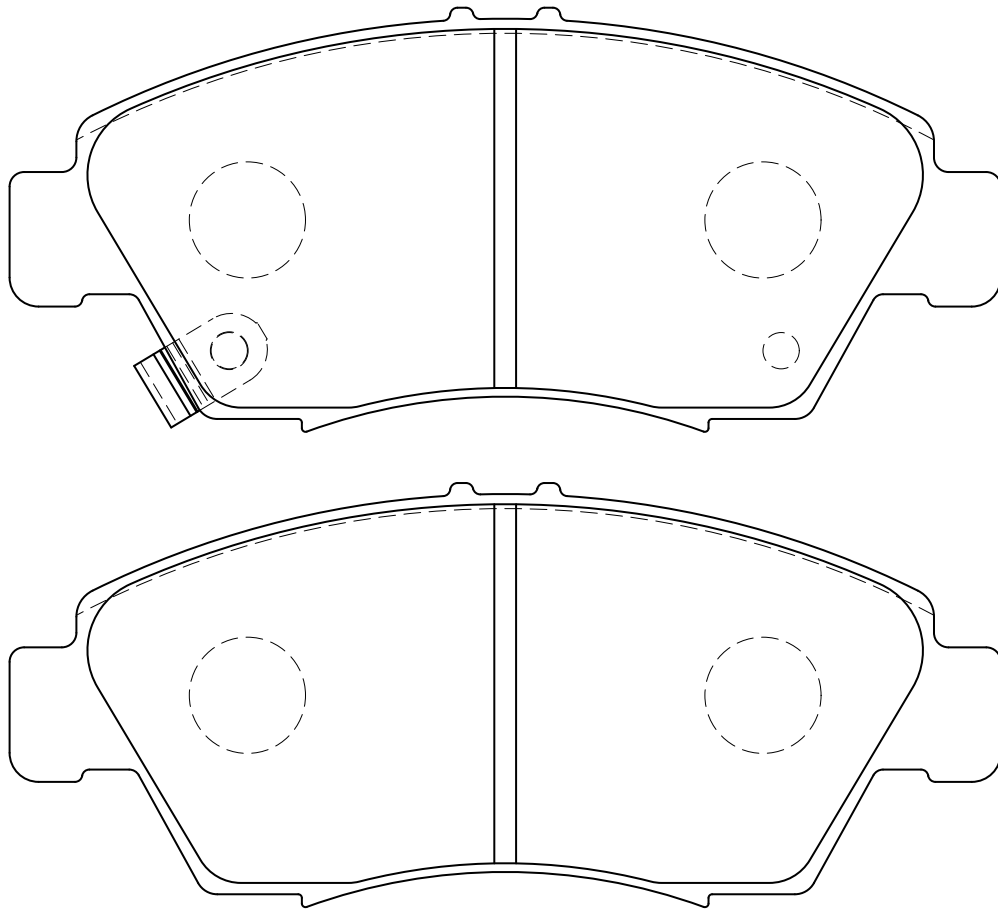

W:136.5 × H:51.5 × T:16.5