

The **REVSPEC**
PRIMES

PR-H529

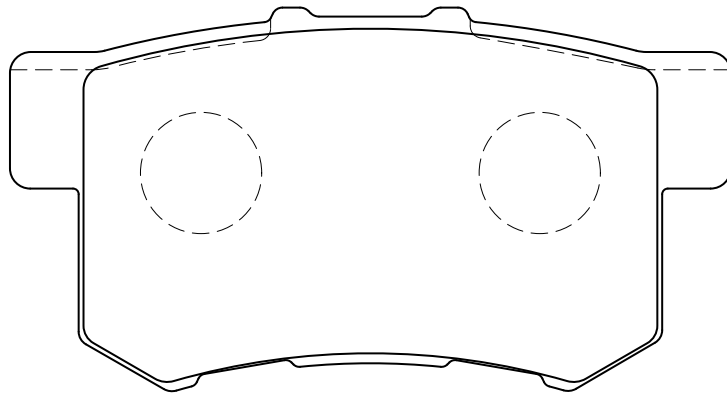
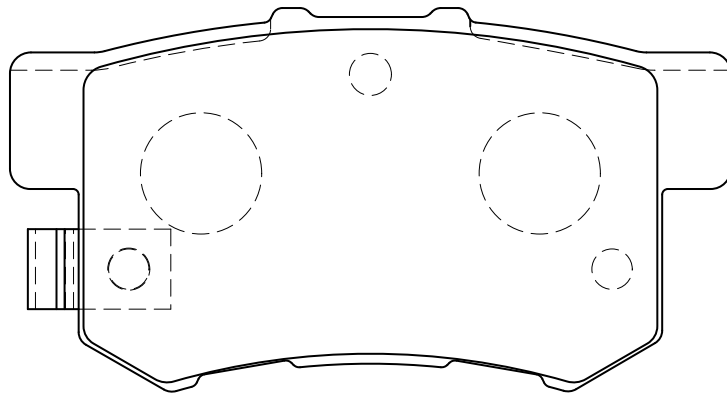

W:88.7 × H:42.5 × T:14.5