

*The* **REVSPEC**  
**PRIMES**

PR-N216

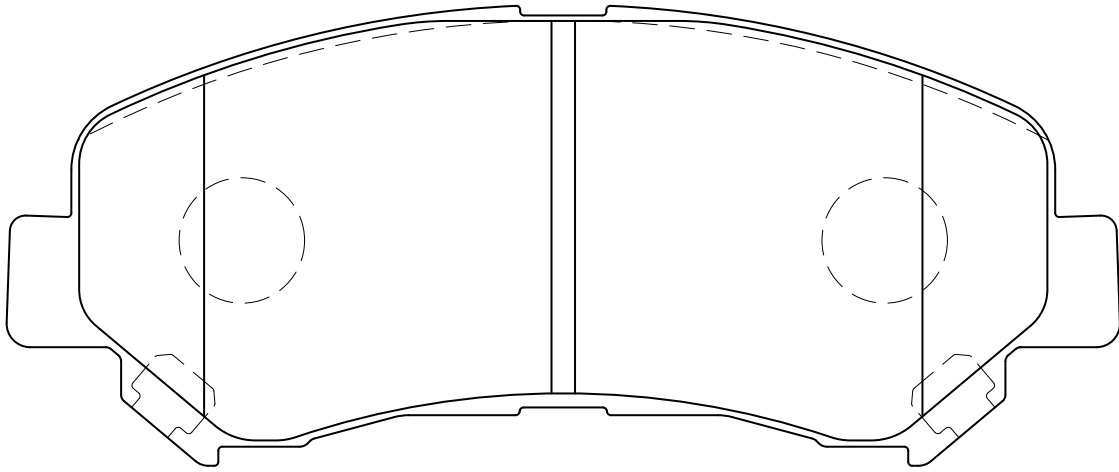

W:142 × H:50 × T:16.8