

The **REVSPEC**
PRIMES

PR-Z160

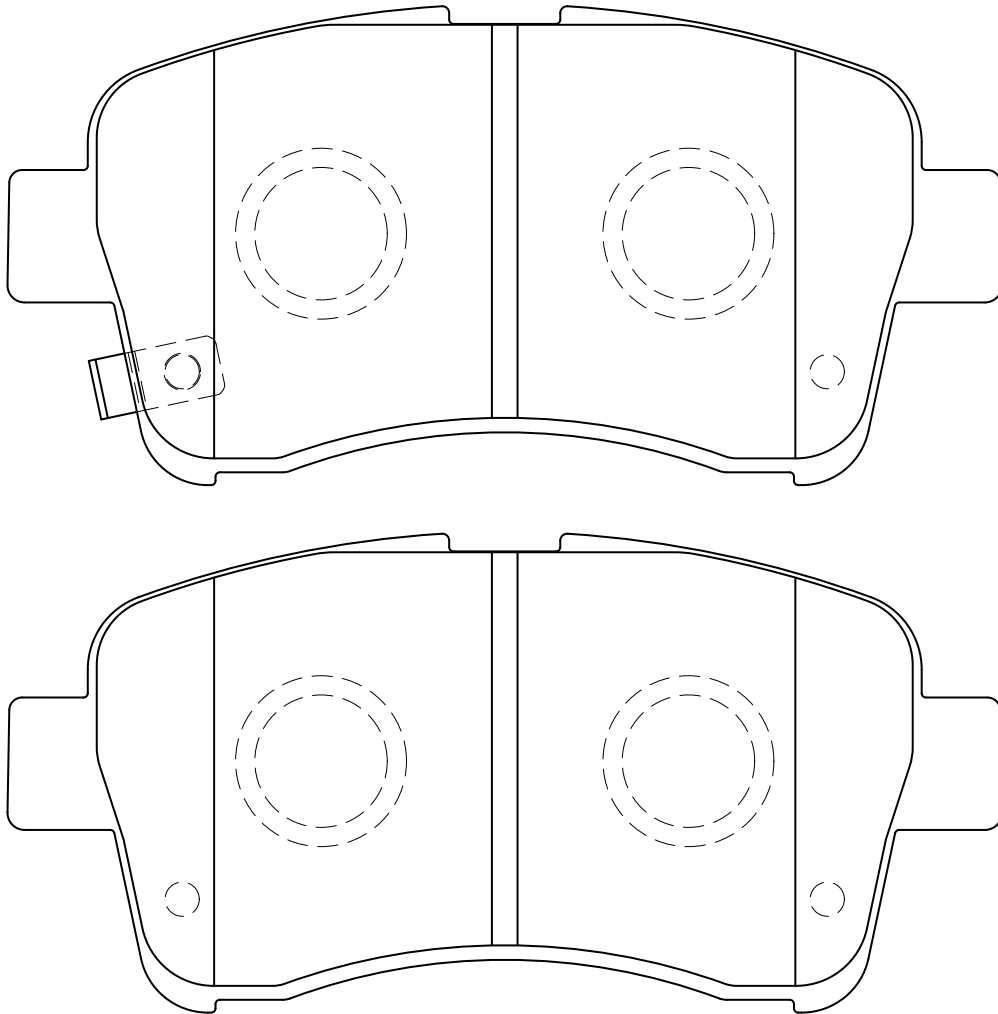

W:116.6 × H:56.3 × T:15.5